

PRODUCT SPECIFICATION GUIDE 2021



Low Maintenance and Barefoot Friendly

- EZ Dock polyethylene docks are durable and slip resistant
- Won't splinter or rot, never needs painting
- Cleans easily with soap and water



Adaptable Design

- Unique design delivers outstanding load capacity, functionality, and safety
- Variety of dock sections, boat/PWC lifts, and kayak launches
- Easily customizable design to make your perfect waterfront retreat

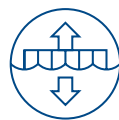

Flexible Flotation Technology

- Flotation chambers constructed for optimal strength and structural integrity
- Designed to provide additional stability on the water
- Dock sections adapt easily to changing water conditions and levels



Innovative Coupling

- Made of recycled materials
- Nuts and bolts made of heavy duty, rust resistant composite
- Strength and durability even in the harshest weather conditions

DOCK SECTIONS

They have the best features built right in. These sections are molded to be durable, slip-resistant and low-maintenance. Slip-resistant texture is molded right into the top, so these docks are safer than wood or concrete for bare feet. The materials are made to last, with no need for repainting or maintenance for rot and splintering.

They create customizable dock systems. Our dock sections come in multiple shapes and sizes, so they can be configured to your exact specifications. The range of choices means you get the design you need for your commercial or residential dock.

They are more durable. Traditional floating docks are one section, which can make them stiff and unyielding in harsh weather, increasing the risk of damage. In bad weather, EZ Dock sections move independently, making your system stronger and more resistant to damage. This bit of give has allowed EZ Dock systems to withstand even tropical storms.

They are easy to install. All you need to do is join each section with the innovative couplings and tighten the bolts. Your dock will be up and running in no time, providing a perfect spot for boating, fishing and swimming.



A
40" DOCK

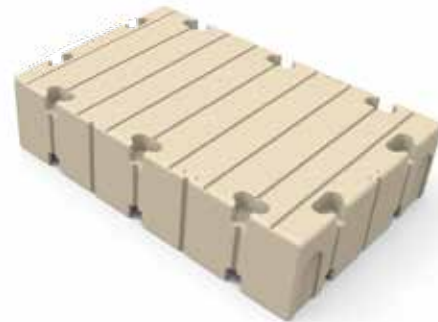

B
BABY DOCK



C
60" DOCK



D
80" DOCK



E
100" DOCK

DOCK SECTIONS



F
LOW PROFILE DOCK



G
HALF HEX DOCK



H
TRI DOCK



I
COUPLER SET with HARDWARE

PART #	BEIGE / GREY	MODEL	COLOR	SIZE	WEIGHT	FLOTATION	MATERIAL
A	204010 / 204010-EZGR	40" Dock Section	Beige & Grey	39" X 117" X 14.625"	167	2000	LLDPE
B	204060 / 204060-EZGR	Baby Dock Section	Beige & Grey	39" X 58.5" X 14.625"	95	1000	LLDPE
C	206010 / 206010-EZGR	60" Dock Section	Beige & Grey	58.5" X 117" X 14.625"	257	3000	LLDPE
D	208008 / 208008-EZGR	80" Dock Section	Beige & Grey	78" X 117" X 14.625"	295	4000	LLDPE
E	208010 / 208010-EZGR	100" Dock Section	Beige & Grey	92" X 78" X 14.625"	339	3100	LLDPE
F	158010 / 158010-EZGR	80" Low Profile Dock Section	Beige & Grey	78" X 117" X 7.625"	250	1900	LLDPE
G	260120 / 260120-EZGR	Half Hex Dock Section	Beige & Grey	50.5" X 59" X 117" X 14.625"	189	2000	LLDPE
H	300503 / 300503-EZGR	Tri Dock Section	Beige & Grey	58.125" X 58.125" X 80.8125" X 14.625"	70	750	LLDPE
I	301100	Coupler Set with Hardware	Black		7	N/A	Recycled Rubber
	301200	Coupler Set with Hardware 2 Pair	Black		14	N/A	
	301300	Coupler Set with Hardware 3 Pair	Black		21	N/A	

PWC PORTS

Ease of use and access. EZ Ports feature a raised bow that helps prevent overshooting the port, with no winching, cranking, pumping or hoisting needed.

Flexibility. All EZ Ports can be linked together and easily adapted to other floating and fixed docks using our revolutionary EZ Port® coupler system with EZ Dock connectors.

Stability. Our proprietary flotation chamber and pylon design provides enhanced buoyancy and stability to reduce movement even in rough water and stormy conditions. EZ Port also provides plenty of space on the front and either side of the port to allow PWC users to find their footing comfortably.

Protection. EZ Port PWC lifts move with changing water levels, protecting personal watercraft from waves, wind and the damage they can cause. Our personal watercraft floating docks are also covered by an industry-leading 8-year warranty.

Low maintenance and barefoot friendly. EZ Dock's polyethylene ports are durable and slip resistant. They won't splinter or rot and never need painted. They are easy to clean with a pressure washer or EPA-approved cleaning solutions.



A
EZ PORT 280



B
EZ PORT VXP



C
EZ PORT 2i

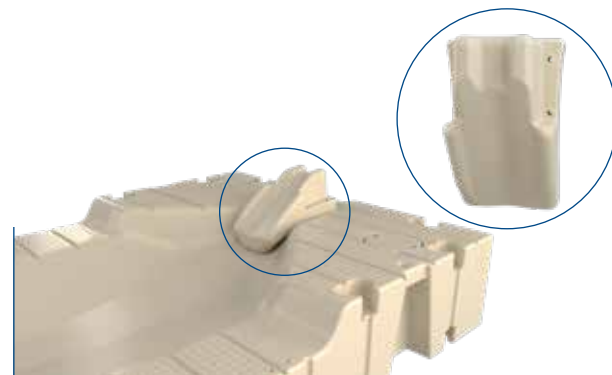

D
BOW STOP KIT, 2i

PART #	BEIGE / GREY	MODEL	COLOR	SIZE	WEIGHT	FLOTATION	MATERIAL
A	208013PW / 208013PW-EZGR	EZ Port 280	Beige & Grey	156" x 80" x 15"	330	Supports all Rec & Rec-Light PWC's	LLDPE
B	206037PW / 206037PW-EZGR	EZ Port VXP	Beige & Grey	153" x 58.5" x 14.625	335		LLDPE
C	206036PW / 206036PW-EZGR	EZ Port 2i	Beige & Grey	168" x 58.5" x 14.625	350	Compatible with all PWC currently on the market.	LLDPE
D	206028BS-EZ / 206028BS-EZGR	Bow Stop Kit, 2i	Beige & Grey				

EZ PORT MAX INLINE

The modular, adjustable and expandable EZ Port MAX PWC port system is built to accommodate multiple PWCs of different shapes. The EZ Port MAX is one of the most flexible options available and can be customized to maximize slip spaces with tandem inlines that help you accommodate more PWCs per slip. Just configure the design that best suits your waterfront and adjust the design any time your needs change. An ideal solution for rental locations or marinas where high density PWC storage is needed.

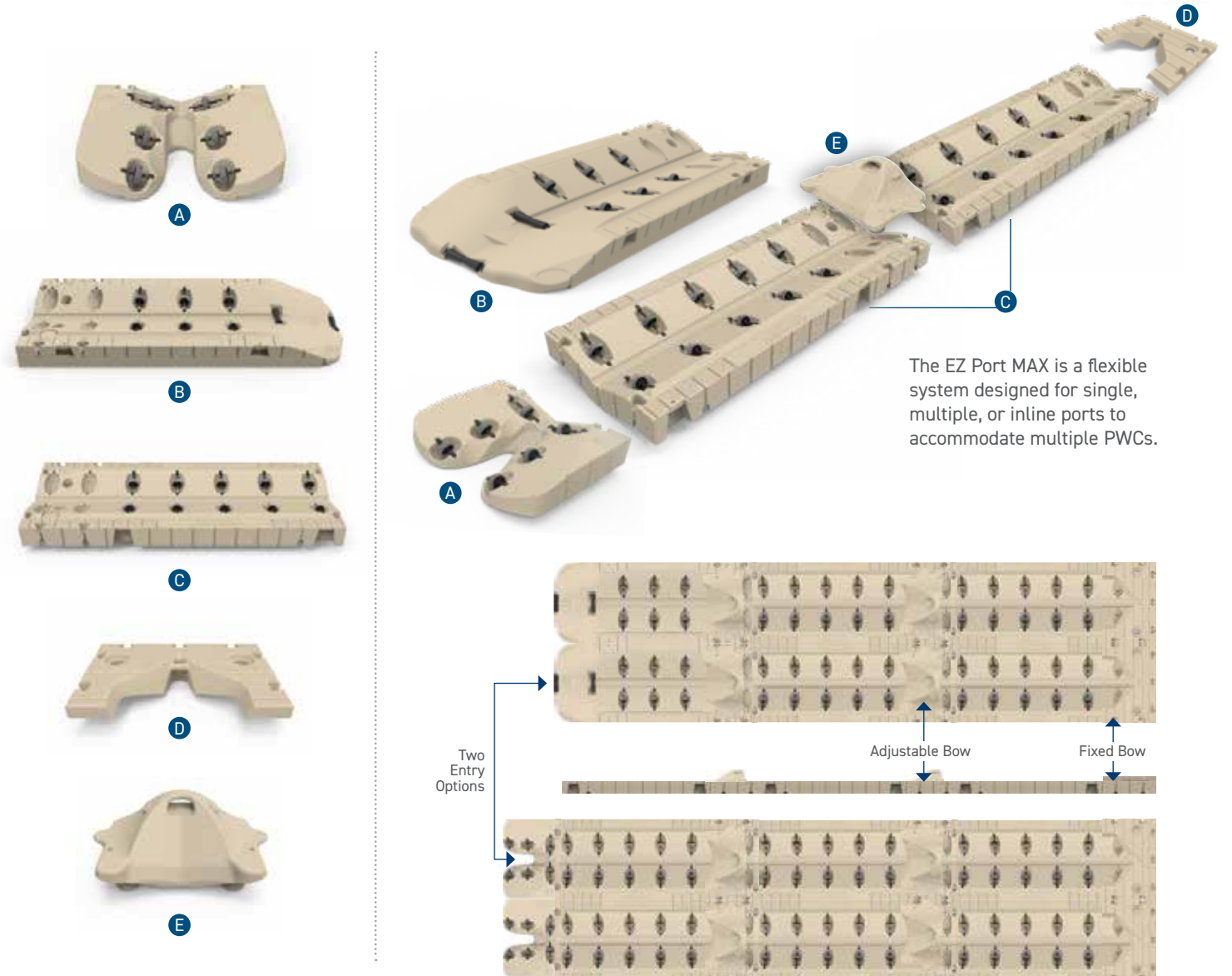

The EZ Port MAX is a flexible system designed for single, multiple, or inline ports to accommodate multiple PWCs.

PART #	BEIGE / GREY	MODEL	COLOR	SIZE	WEIGHT	Supports all Rec & Rec-Light PWC's	MATERIAL
A	206033EX / 206033EX-EZGR	EZ Port MAX Easy-Lift Entry	Beige & Grey	43.5" x 58.5" x 10.4375"	95		LLDPE
B	206030PW / 206030PW-EZGR	EZ Port MAX Entry	Beige & Grey	149" x 58.5" x 10.4375"	266	1380	LLDPE
C	203031PW / 206031PW-EZGR	EZ Port MAX Extension	Beige & Grey	146" x 58.5" x 10.4375"	266	1400	LLDPE
D	206025BS / 206025BS-EZGR	EZ Port MAX Full Deck Bow	Beige & Grey	39" x 58.5" x 10.5"	65	N/A	LLDPE
E	206027BS / 206027BS-EZGR	EZ Port MAX Small Bow	Beige & Grey	38.5" x 20.8125" x 15"	16	N/A	LLDPE

EZ LAUNCH® COMMERCIAL

Kayak Launch System for Universal Access

A first in the industry, the EZ Launch® Accessible Transfer System for kayaks and canoes provides individuals with disabilities accessibility that exceeds the minimum requirements of the Americans with Disabilities Act (ADA). The easy-to-use transfer bench and transfer slide boards allow users to simply sit, slide over and drop down into a kayak or canoe then use the side rails to pull off or back on.

EZ Launch Commercial Features

- Guide rails for easy access in and out of water
- Launch rollers for easy movement of the watercraft
- Floating platform that adjust to changing water levels

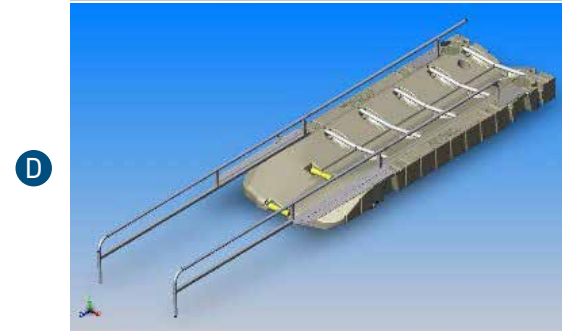
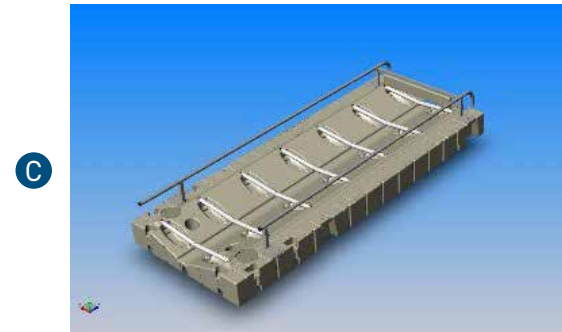
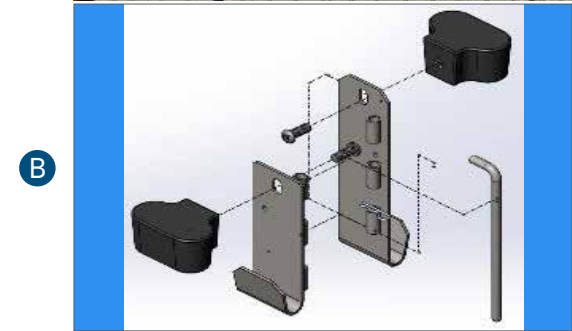
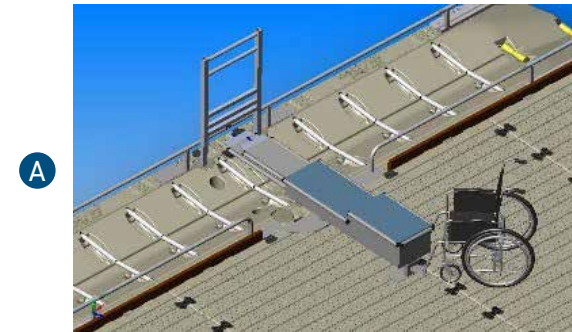
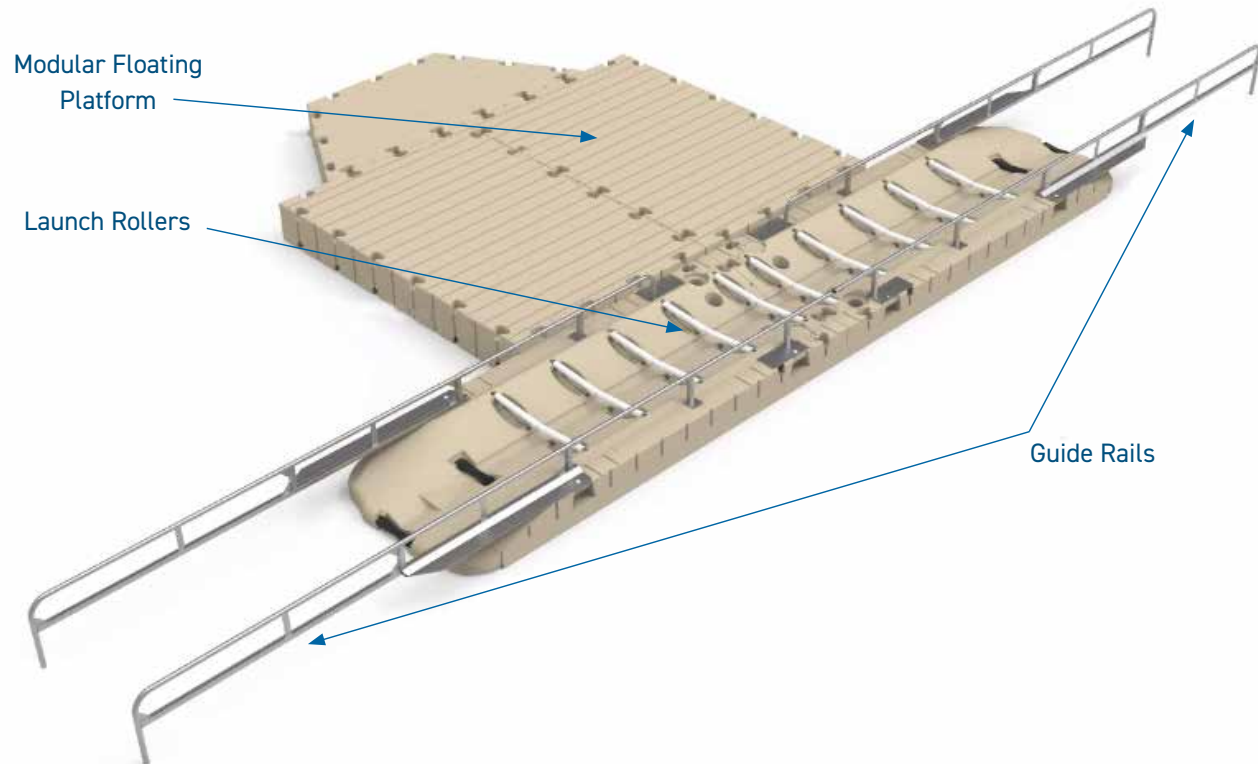

EZ LAUNCH® COMMERCIAL

EZ Launch Universal Access Features

- Transfer bench with two heights and easy transfer from wheelchair
- Transfer slide board with two heights for differing watercraft sizes
- Railing system for slide board stabilization & support for easy movement

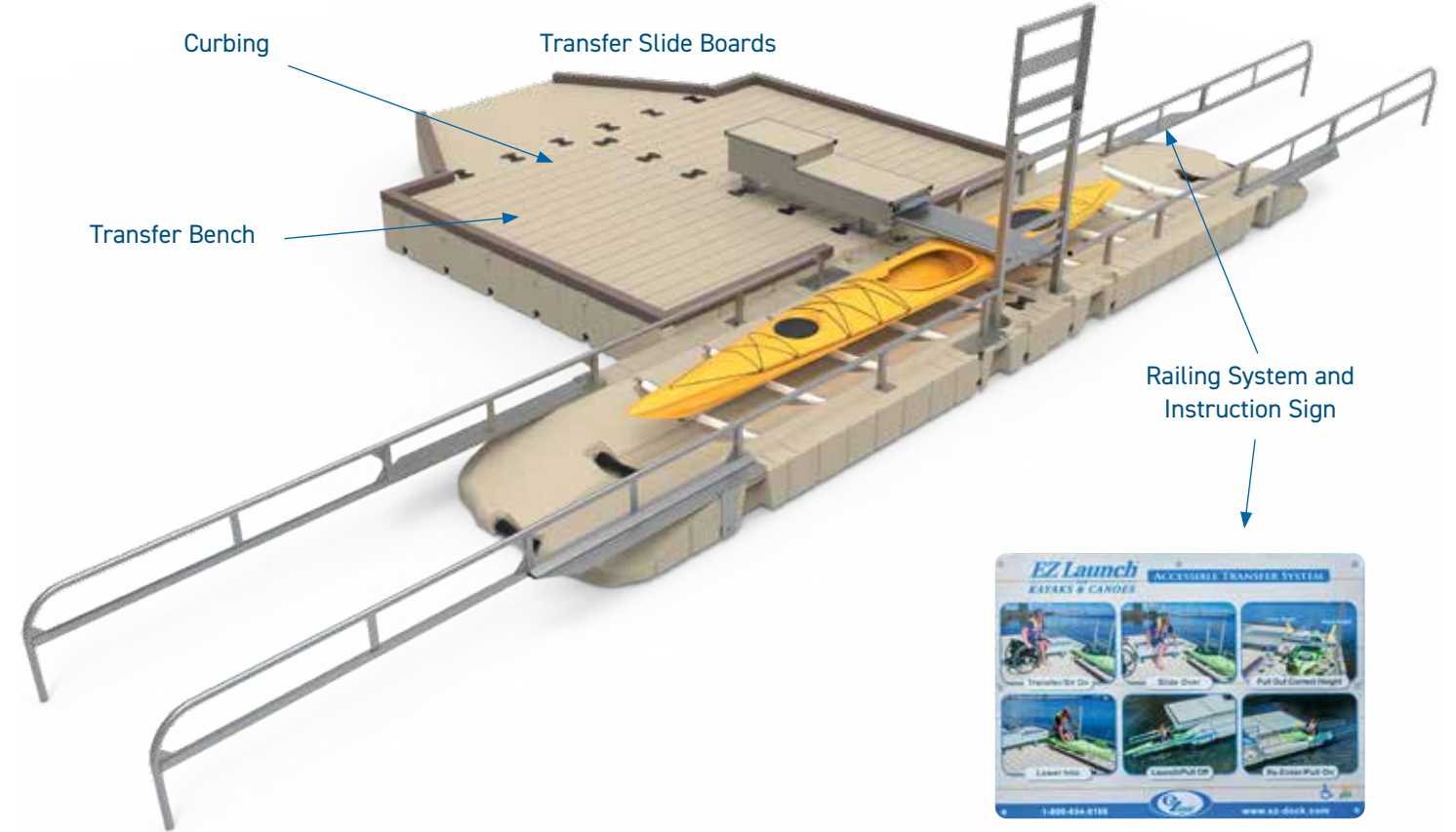

	PART #	MODEL	WEIGHT
A	5008900	EZ Launch Transfer System	350
B	100757SS	EZ Launch Adjustable Adapter Kit	23
C	500901	EZ Launch Extension Railing	126
D	500900L	EZ Launch Entry Railing Left	126
	500900R	EZ Launch Entry Railing Right	126
NOT SHOWN	S50911	PVC Steeved Roller	

Boat Entry Assistance System | Pat. 9708038

EZ LAUNCH® COMMERCIAL CUSTOMIZED SOLUTIONS

EZ Launch® Drive Thru with Transfer Bench & Small Platform

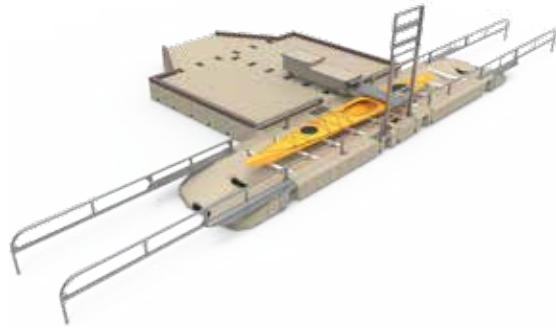

EZ Launch® Multiple One-way with Transfer Bench

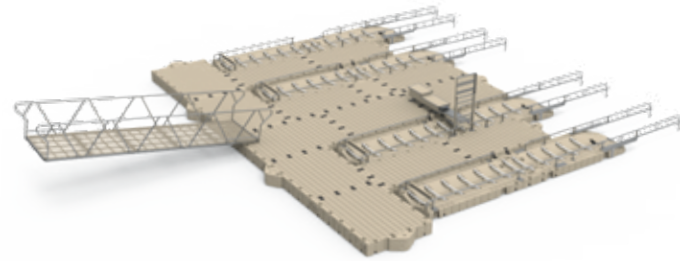

EZ Launch® One-way with Large Platform & Boat Slip

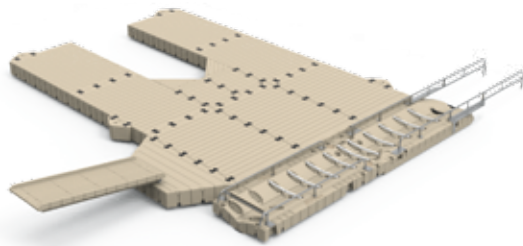

EZ Launch® One-way & Extra-Large Platform

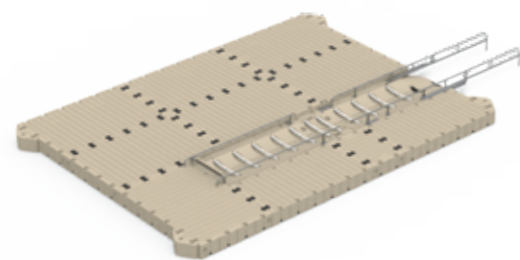

EZ Launch® One-Way with Transfer Bench, Handrail & Large Platform

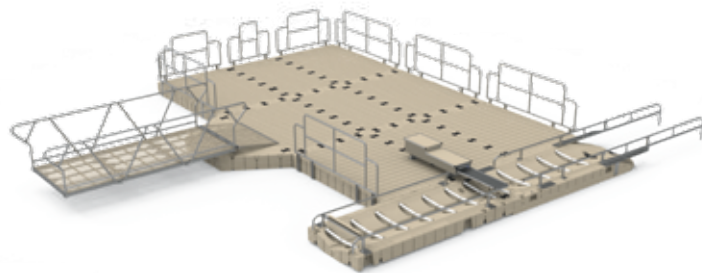

EZ Launch® One-way & Large Platform

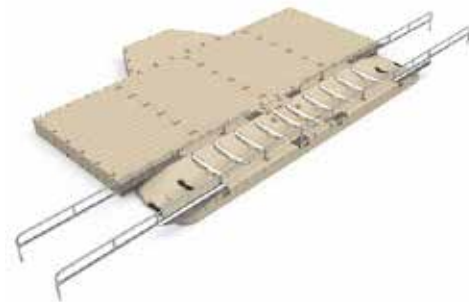

EZ Launch® Drive Thru with Small Platform & Tri Dock

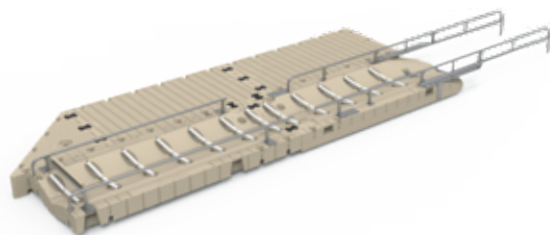

EZ Launch® Drive Thru with Small Platform

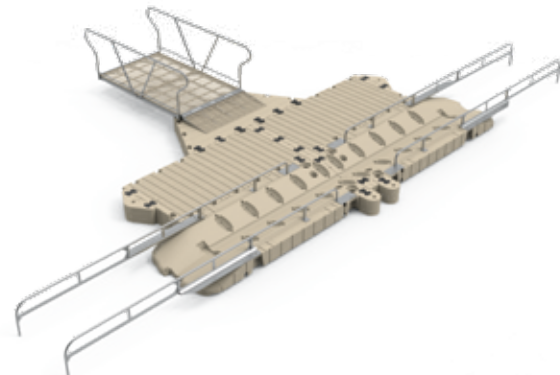

EZ LAUNCH® RESIDENTIAL

EZ Launch Residential Features

- Comfortable: Dock entry enables stable, dry entry.
- Easy to Use: Launch-assist paddle notches support easy entry/exit. V-shaped entry centers vessel upon entry for confident, consistent launch.
- Flexible Design: Engineered to connect with virtually any dock (EZ Dock or any other dock). Fits canoes, tandem kayaks, stand-up paddleboards, etc.

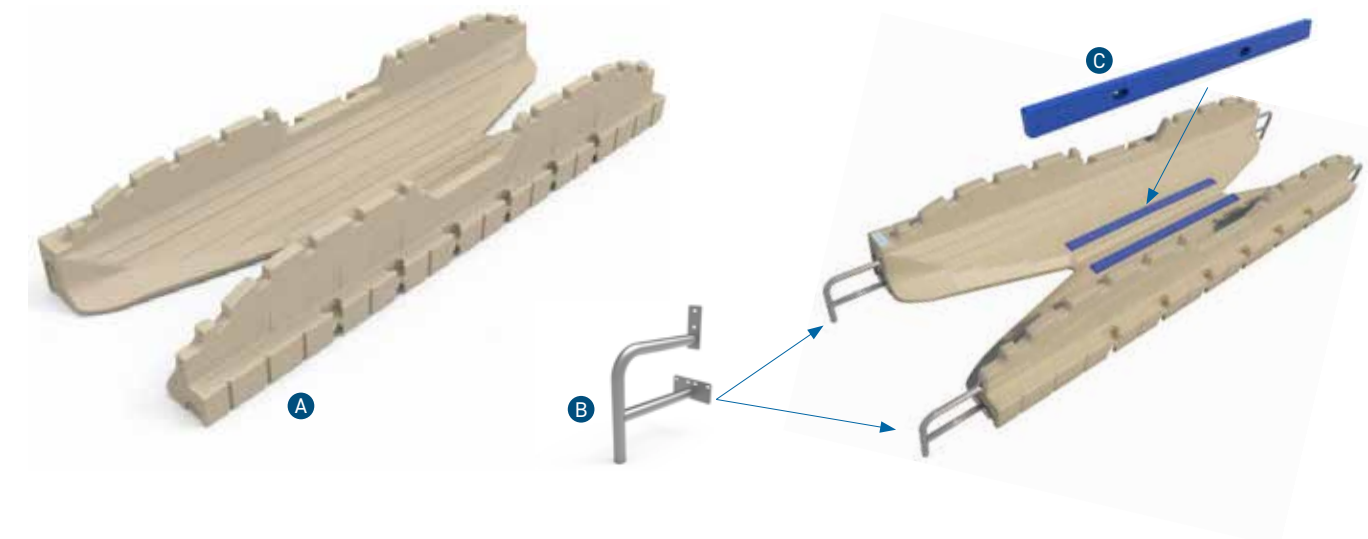
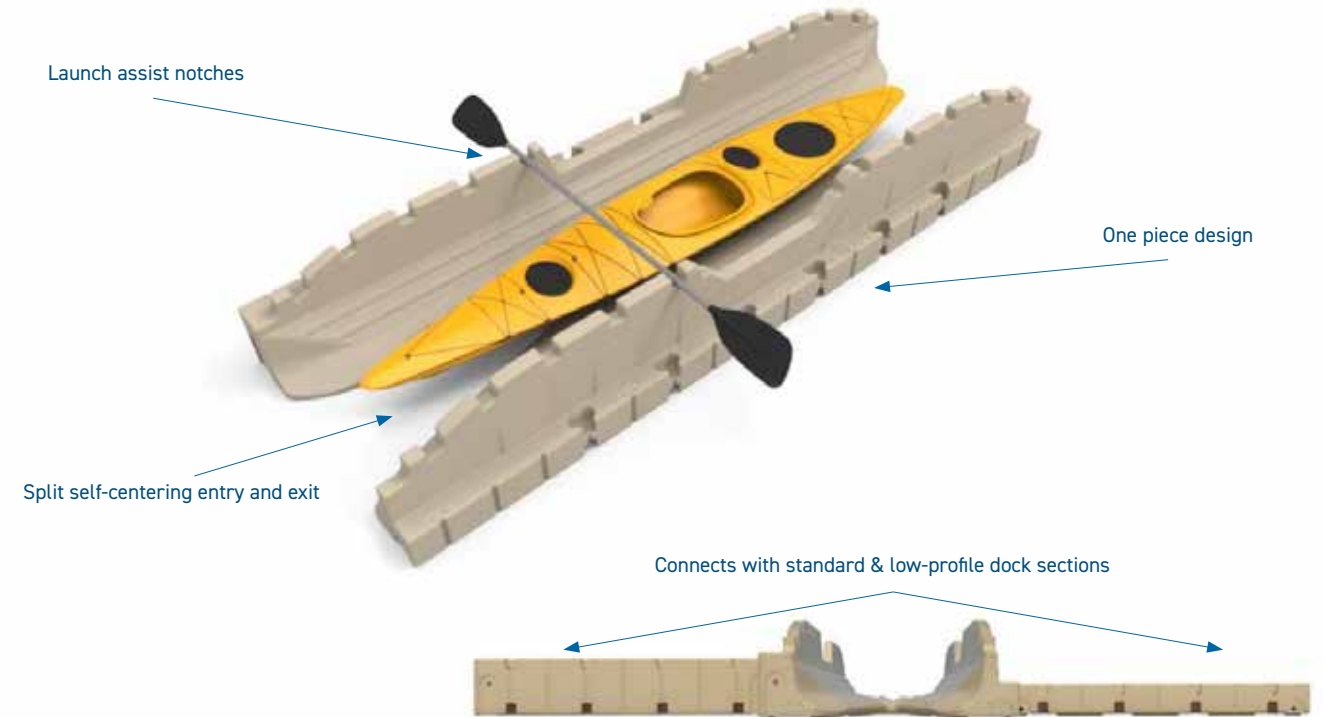

	PART NUMBER	MODEL	COLOR	SIZE	WEIGHT	FLOTATION	MATERIAL
A	200900	EZ Kayak Launch (Residential)	Beige	168" x 58" x 24"	325	750	LLDPE
	200900-EZGR	EZ Kayak Launch (Residential)	Grey	168" x 58" x 24"	325	750	LLDPE
B	200683	EZ Kayak Launch Extension RAIL	Aluminum			N/A	
C	208112	EZ Kayak Launch Slide Bunk Kit	Blue			N/A	

EZ BOATPORT® & EZ PORT AIR ASSIST PUMPS

The EZ BoatPort is a simple and stable drive-on, drive-off method of docking for boats in a wide range of sizes up to 4,000 lbs.

EZ BoatPort Features

- Configurations to fit multiple boats shapes and sizes
- Works with existing floating or fixed docks
- Can be used in as little as 2 ft. of water
- No winching, cranking or hoisting
- Two skid bunk options to fit a variety of hull shapes and sizes
- Up to three additional keel rollers for longer boats
- Optional supplemental flotation kit for added buoyancy
- Optional side extensions for additional walk-around room

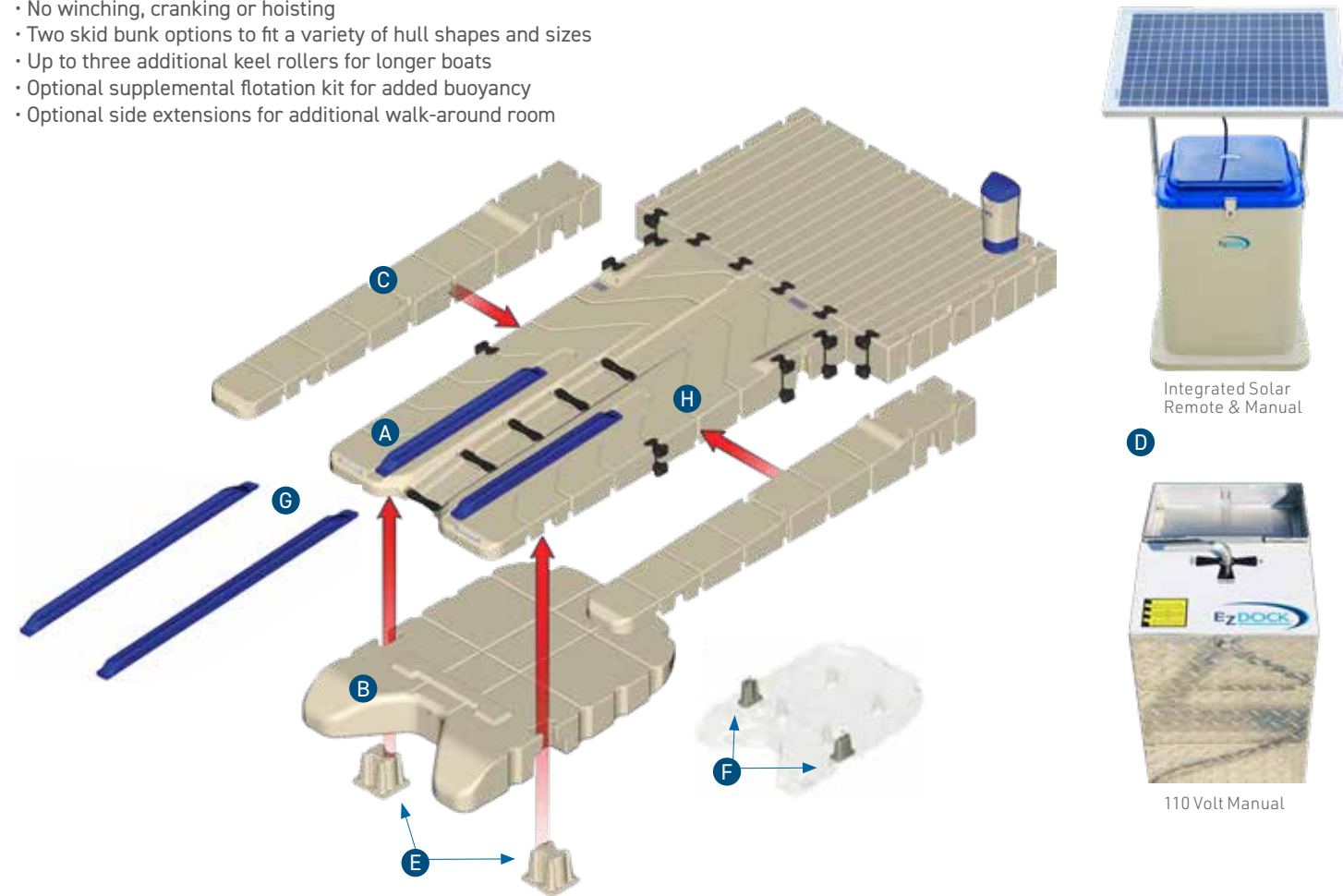

PART # (BEIGE / GREY)	MODEL	COLOR	SIZE	WEIGHT	FLOTATION	MATERIAL
A	208015BL / 208015BL-EZGR	Beige & Grey	164" x 78" x 14.625"	500	2000	LLDPE
B	208015FT / 208015FT-EZGR	Beige & Grey	111" x 78" x 19.625"	240	2000	LLDPE
C	208015EX / 208015EX-EZGR	Beige & Grey	164" x 20" x 14.625"	140	500	LLDPE
D	600046-IS	Beige & Grey	Box: 15" x 13" x 27.5" Solar Panel: 27.5" x 23.75" x 1.25"		N/A	LLDPE
	600048-IS	Beige & Grey	Box: 15" x 13" x 27.5" Solar Panel: 27.5" x 23.75" x 1.25"		N/A	LLDPE
	600053	Aluminum Diamond Plate	16" x 14" x 20"		N/A	Aluminum
	600052	Aluminum Diamond Plate	16" x 14" x 20"		N/A	Aluminum
E	208104 / 208104-EZGR	Beige & Grey	13.5" x 7.5" x 12"	15	N/A	LLDPE
F	208105 / 208105-EZGR	Beige & Grey	13.5" x 7.5" x 12"	7	N/A	LLDPE
G	208101	Blue	108" x 8" x 10"	35	N/A	LLDPE
H	208102	Blue	75" x 8" x 5"	33	N/A	LLDPE

EZ BOATPORT® CUSTOMIZED SOLUTIONS

EZ Dock commercial and residential boat ports are a fast and simple solution if you need a low-maintenance, stable, durable, drive-on boat dock.

Add On Features:

- Two skid bunk options to fit a variety of hull shapes and sizes
- Up to three additional keel rollers for longer boats
- Supplemental flotation kit for added buoyancy
- Optional side extensions for additional walk-around room
- Flip-up front cleat to secure the boat to the port

EZ BoatPort with Side Extensions

System Dimensions: 9'9" W x 13'8" L (140 sf)

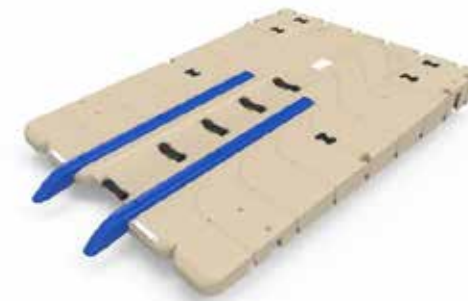

EZ BoatPort with Float Tank & Air Assist

System Dimensions: 6'5" W x 18'6" L (124 sf)

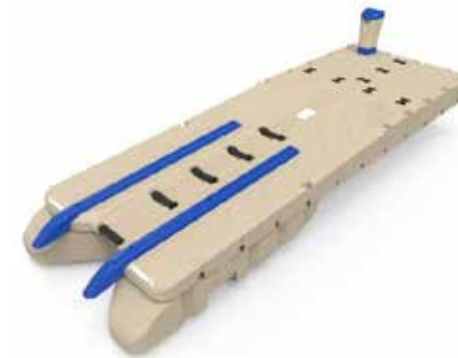

EZ BoatPort with Side Extensions, Float Tank, & Air Assist

System Dimensions: 9'9" W x 20'2" L (205 sf)

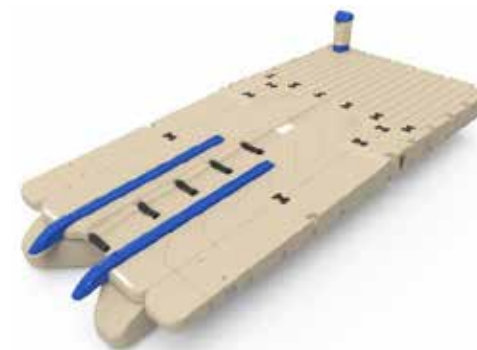

EZ BoatPort with Side Extensions & Large Platform

System Dimensions: 9'9" W x 18'6" L (190 sf)

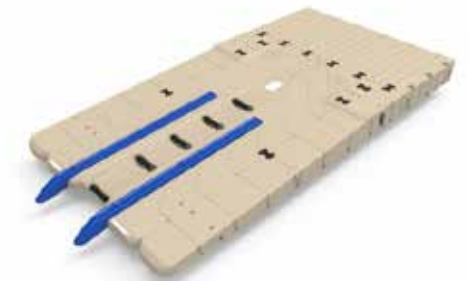

EZ BoatPort with Float Tank, Air Assist, & Large Platform

System Dimensions: 6'5" W x 26'5" L (156 sf)

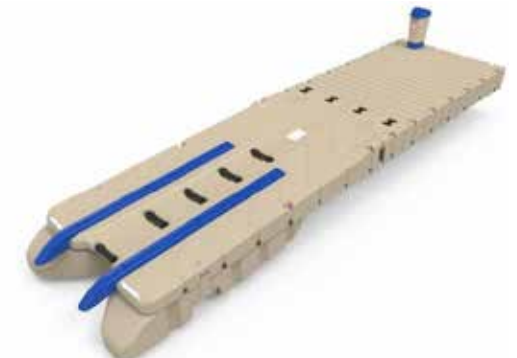

EZ BoatPort with Side Extensions, Float Tank, Air Assist, & Large Platform

System Dimensions: 9'9" W x 23'5" L (240 sf)

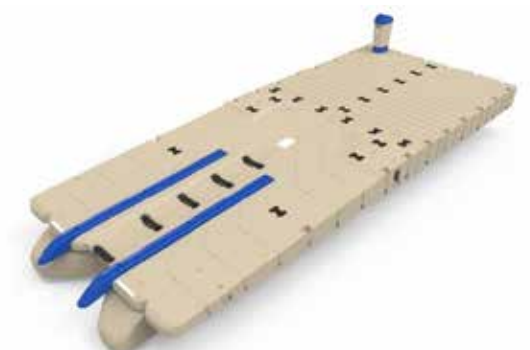

ANCHORING

Once you've created your EZ Dock, you'll need to select an anchoring system to work with your existing piling or your new installation. Our wide variety of anchoring components can accommodate most water conditions and bottoms (deep, shallow, rough, muddy, or sandy) and are simple to install. EZ Dock anchoring products are made from long-lasting, durable materials that can accommodate standard or heavy-duty use. Your local dealer can help you select the anchoring system that's right for your location. Call us at 1-800-654-8168.



STANDARD PIPE BRACKET
Standard-duty polyethylene bracket provides ample anchoring for EZ Port PWC lifts, or for smaller docks in moderate conditions.



HEAVY-DUTY PIPE BRACKET
Heavy-duty polyethylene pipe bracket allows docks to adjust to changing water levels.



HEAVY DUTY PIPE BRACKET WITH INSERT
Heavy-duty polyethylene pipe bracket allows docks to adjust to changing water levels.



STIFF-ARM BRACKET
Includes hardware. Order stiff-arm insert, post sleeve, and anchoring pipe separately.



STIFF-ARM HEAVY DUTY BRACKET
Anchor to a shoreline abutment or to a shoreline post with our heavy-duty stiff-arm. Light-duty stiff-arm bracket also available.



POLY PIPE STAND-OFF BRACKET
Polyurethane bracket attaches top of pipe to stationary docks. Fits pipe from 2.5" to 3.5" O.D.



ADJUSTABLE PILING BRACKET
Heavy-duty one-piece polyethylene bracket allows lateral position adjustment to attach to piles from 6"-18" in diameter. Bracket comes with two pairs of couplers with composite hardware.



PILING BRACKET AND HOOPS
Predrilled for hoops (sold separately) and includes nuts and connectors. SS hardware available.

PART NO.	MODEL	SIZE
A	135250 Standard Pipe Bracket	For 2.375" (6cm) O.D. Pipe
	135350 Standard Pipe Bracket	For 3.5" (9cm) O.D. pipe
B	215250 Heavy-Duty Pipe Bracket	For 2.375" (6cm) O.D. pipe
	215350 Heavy-Duty Pipe Bracket	For 3.5" (9cm) O.D. pipe
C	210250 Heavy-Duty Pipe Bracket with Insert	For 2.375" (6cm) O.D. Pipe
	210350 Heavy-Duty Pipe Bracket with Insert	For 3.5" (9cm) O.D. pipe
D	100700 Stiff-Arm Bracket	Mainframe Bracket
	800095-15 Stiff-Arm Bracket	2" I.D. post sleeve for stiff arm
E	800099 Stiff-Arm Heavy Duty Bracket	Frame & Yoke (as shown)
	S80094 Stiff-Arm Heavy Duty Bracket	Sea wall attachment bracket
F	800099 Poly Pipe Stand-Off Bracket	Frame & Yoke (as shown)

PART NO.	MODEL	SIZE
G	300810 Adjustable Piling Bracket (NEW)	
H	100800 Piling Bracket (for hoops below)	
	100804 Hoop for Piling Bracket	4" Hoop
	100806 Hoop for Piling Bracket	6" Hoop
	100808 Hoop for Piling Bracket	8" Hoop
	100812 Hoop for Piling Bracket	12" Hoop
	100816 Hoop for Piling Bracket	16" Hoop
	100820 Hoop for Piling Bracket	20" Hoop
	100824 Hoop for Piling Bracket	24" Hoop

ANCHORING



DEADWEIGHT BRACKET
For light-duty anchoring with chain and/or to attach 4" (10cm) x 4" (10cm) railing or mooring posts. Sold in Pairs. Chain sold separately.



DEADWEIGHT SLEEVE INSERT
Deadweight insert anchors heavy-duty PE pipe bracket to docks in deep water or rocky bottoms.

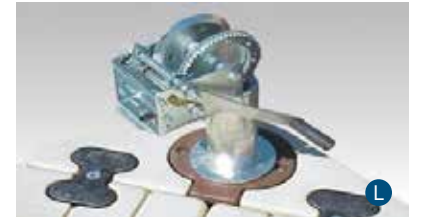

DEADWEIGHT WINCH INSERT
Deadweight insert and cable winch added to our polyethylene pipe bracket allow easy dock adjustment for water fluctuations. Cable sold separately.



ADAPTOR HINGE
Reversible hinge allows EZ Port PWC lifts or EZ Dock sections to be attached to other floating docks.



PIPE AUGERS
Auger with bolt and nut allows for drilling and setting pipe in lake, river, or ocean bottoms. Pipe sold separately.

PART #	MODEL
J	100740 Deadweight Bracket Kit
	100740SS Deadweight Bracket Kit Stainless
K	215350 Bracket & Insert for 3.5" O.D. pipe
	100725P Deadweight insert for #210350 assembly
L	100730 Deadweight winch insert
	210350 Heavy Duty Dock Bracket for winch insert
M	100750 Adapter Hinge
	100750SS Adapter Hinge Stainless
	100751 EZ Port Adapter Hinge
	100751SS EZ Port Adapter Hinge Stainless
N	100255 Pipe Auger (For 2.375" OD Pipe)
	100355 Pipe Auger (For 3.5" OD Pipe)

ACCESSORIES

With the EZ Dock modular system, you can add a wide variety of accessories including storage boxes, bumpers, cleats, benches, ladders, and slides using our easy-to-use coupling system. Do you have a specialty item or piece of equipment that you want affixed to your dock? Simply use our hardware connectors to bolt it directly to the section you choose. It's that easy.



CORNER STORAGE BOX
This roomy storage box's compact design makes the most of available space without interfering with foot traffic. Also available in connection boxes for complete utility hookups.



STORAGE BOX
Permanently mounted and constructed of weather-resistant materials, the EZ Dock Storage Box is a great place to store life jackets, towels and other essential supplies.



CORNER GUSSET
Polyethylene corner gusset adds deck surface and additional stability to dock fingers when needed. 33.5" (85cm) wide, 6" (15cm) high.



SWIM LADDER
One-piece polyethylene ladder is designed for maximum safety with no exposed hardware and 400 pounds of weight capacity. Slip-resistant textured surface stays cool in hot weather.



DOCK BUMPER
This dock bumper is designed to protect the boat gunwales and rub-rails. Dock bumper will attach to dock using embedded T-nuts.



POLY BENCH WITH ARM-RESTS
Redesigned brackets with 2" round, .25" aluminum tubing. Installs along any open 3-pocket span on an EZ Dock product.



POLY BENCH WITHOUT ARM-RESTS
Redesigned brackets with 2" round, .25" aluminum tubing. Installs along any open 3-pocket span on an EZ Dock product.



IN-WATER INSTALLATION TOOL
Tool simplifies in-water connection of dock sections.

	PART # (BEIGE / GREY)	MODEL	COLOR
A	300760 / 300760EZGR	Corner Storage Box w/Gusset	Beige & Grey
B	300750 / 300750EZGR	Storage Box	Beige & Grey
C	300501 / 300501EZGR	Corner Gusset	Beige & Grey
D	300260 / 300260EZGR	Swim Ladder	Beige & Grey
E	300180 / 300180EZGR	Dock Bumper	Beige or Grey
F	300970AL / 300970ALEZGR	Poly Bench with Arm-rests	Beige & Grey
G	300965AL / 300965ALEZGR	Poly Bench without Arm-rests	Beige & Grey
H	900010SS	In-Water Installation Tool	Aluminum

ACCESSORIES



TIE-DOWN CLEAT
Tie-down cleat (8") and other accessories attach to heavy-duty stainless-steel T-nuts molded in pairs around dock section perimeters.



TIE-DOWN CLEAT
Tie-down cleat (10") and other accessories attach to heavy-duty stainless-steel T-nuts molded in pairs around dock section perimeters.



UTILITY CHANNEL
Two-piece chaseway attaches to dock sections for utility lines. Stainless steel hardware option.



DOCK SLIDE
Utilizes rugged polyvinyl-coated steps, and a one-piece polyethylene bedway for a smooth ride. Install with almost any EZ Dock* where water depth is more than 5'. (Requires use of (2) 80" dock sections.)



SUPPLEMENTAL FLOTATION
Attaches under EZ Port 3 lifts to increase the flotation capacity in specific applications.



SUPPLEMENTAL FLOTATION POD
This float pod is designed to add 200lbs (91 kg) of flotation and is sized to fit under most dock pylon shapes.



POLY POST HANDRAILS
Attaches to the coupler pocket. Can be used as a grab or accessory attachment post. 8 embedded T-nuts for cleat attachment, and recessed holes that can be drilled for tube or rope handrails. (Handrails and Cleats not included.)



DOCK WHEELS
Steel frames with polyethylene wheels make movement of docks easier. Sold in pairs.



HARDWARE CONNECTORS (M/F)
For attaching various accessories. .625" SS bolts and nuts.

	PART #	MODEL	COLOR
J	300100	8" Tie-down Cleat	Black
K	300110	10" Tie-down Cleat	Aluminum
L	302060	5' x 20" Utility Channel	Beige & Grey
	302020	20" x 20" Utility Channel	Beige & Grey
	302030	20" Inside Corner	Beige & Grey
	302040	20" Outside Corner	Beige & Grey
M	300600	Dock Slide	Blue
	300600FG	Dock Slide	Forest Green

	PART #	MODEL	COLOR
N	206013FL	Supplemental Flotation	Beige or Grey
O	208110	Supplemental Flotation Pod	Beige & Grey
P	100900	Poly Post Handrails	Beige & Grey
Q	900050	Dock Wheels	Black
R	201040SS	Hardware Connector Male	Black
	201041SS	Hardware Connector Female	Black

RAILING

Aluminum 42" (1.1m) high guardrails conform with SOBA and ADA guidelines, and are designed to provide security with minimal obstruction. Choose the standard aluminum finish, or optional powder-coated finish—available in sand, royal blue, brown, forest green (shown below right). Hardware included.

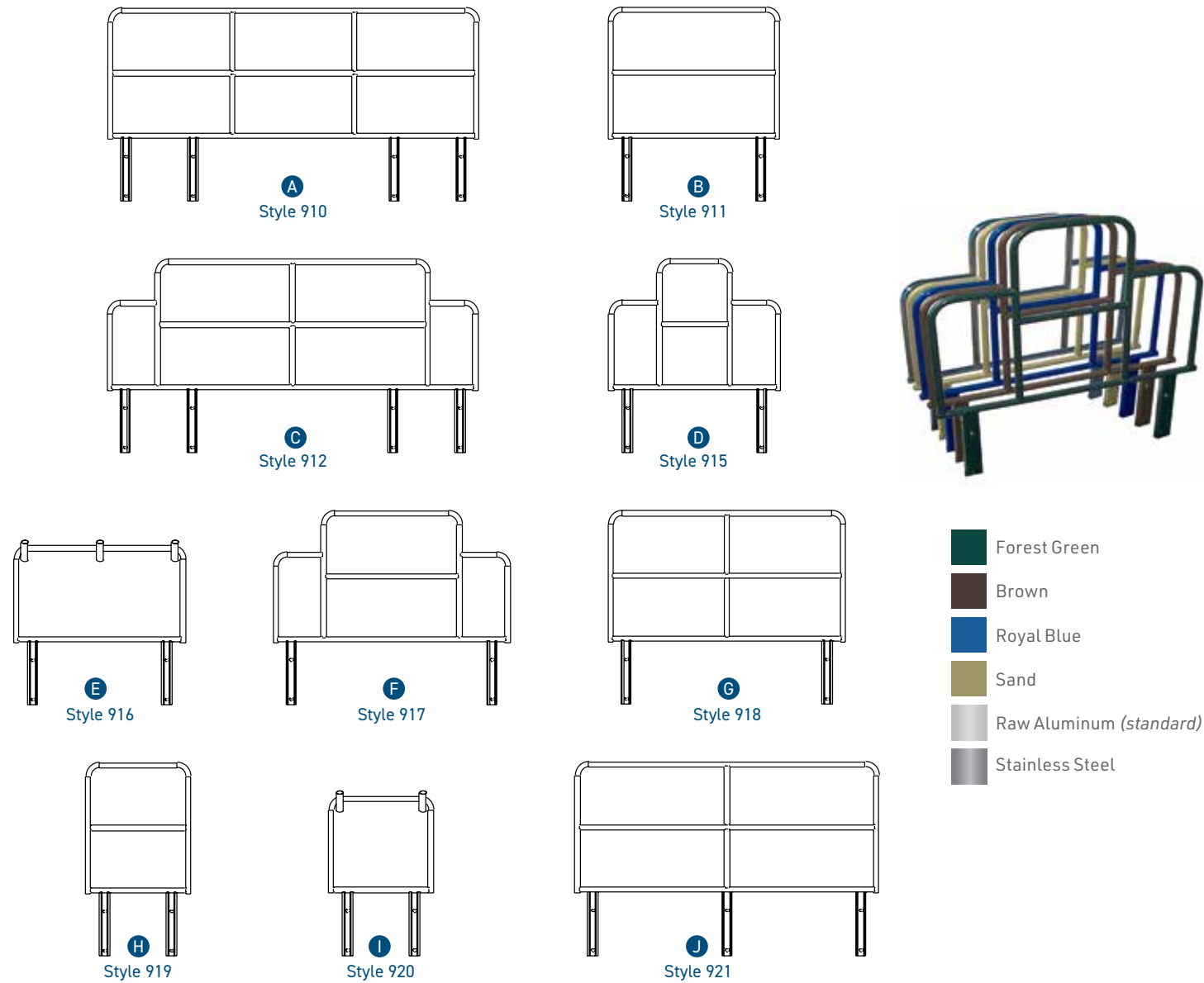

	PART NUMBER	MODEL	SIZE
A	100910AL	Style 910 Aluminum	10' (3m) Width
	105910	Style 910 Powder Coated Aluminum	10' (3m) Width
B	100911AL	Style 911 Aluminum	5' (1.5m) Width
	105911	Style 911 Powder Coated Aluminum	5' (1.5m) Width
C	100912AL	Style 912 Aluminum	10' (3m) Width
	105912	Style 912 Powder Coated Aluminum	10' (3m) Width
D	100915AL	Style 915 Aluminum	5' (1.5m) Width
	105915	Style 915 Powder Coated Aluminum	5' (1.5m) Width
E	100916AL	Style 916 Aluminum	5' (1.5m) Width
	105916	Style 916 Powder Coated Aluminum	5' (1.5m) Width

	PART NUMBER	MODEL	SIZE
F	100917AL	Style 917 Aluminum	80" (2m) Width
	105917	Style 917 Powder Coated Aluminum	80" (2m) Width
G	100918AL	Style 918 Aluminum	80" (2m) Width
	105919	Style 918 Powder Coated Aluminum	80" (2m) Width
H	100919AL	Style 919 Aluminum	40" (1m) Width
	105919	Style 919 Powder Coated Aluminum	40" (1m) Width
I	100920AL	Style 920 Aluminum	40" (1m) Width
	105920	Style 920 Powder Coated Aluminum	40" (1m) Width
J	100921AL	Style 921 Aluminum	100" (2.5m) Width
	105921	Style 921 Powder Coated Aluminum	100" (2.5m) Width

BOAT LIFT

EZ Dock's newest entry in the boat lift category is the Aegis™ 7 Boat Lift. This boat lift promotes fast and convenient access to your boat and keeps it looking like new. EZ Dock offers a complete system including new air-assist pumps in both 110 volt (standard) and solar models (optional). Each boat lift is available with manual control (standard) placed near the lift or with remote control (optional). The Aegis boat lift tank system is precision-molded, linear low-density polyethylene (LLDPE), resistant to the worst of weather conditions, and low water damage. The lift keeps the boat out of the water and free from marine growth on outdrives and the hull of your boat. The frame is constructed

from hot-dipped galvanized steel and corrosion-resistant hardware. The lift also allows you to have easy access to your watercraft to eliminate difficult maintenance challenges. The lift is compatible with EZ Dock products and traditional dock systems. Through the use of our air assist pumps, the new boat lift is capable of hoisting boats up to 7,000 lbs. in weight and 28 feet in length. The Aegis 7 Boat Lift features fully adjustable standard bunk locations for V hull boats, with the ability to customize as needed for a variety of hull configurations. The lift also features premium low-friction and high strength ultra-high molecular weight (UHMW) polyethylene bearing surfaces.



AEGIS 7
BOAT LIFT



PART #	MODEL	DIMENSIONS	LIFT CAPACITY	WEIGHT	# OF TANKS	SLIP SIZE	MINIMUM WATER DEPTH	BOAT LENGTH CAPACITY	TANK COLOR
BL7000	AEGIS 7 BOAT LIFT - VHULL	10'-12' Wide x 13' 8" Long	Up to 7000 lbs	~1000 lbs	2	10' - 18'	5'	Up to 28'	BLUE
BL7000PT	AEGIS 7 BOAT LIFT - PONTOON								
BL7000TTT	AEGIS 7 BOAT LIFT - TRITOON								
BL7000WB	AEGIS 7 BOAT LIFT - WAKE BOAT								

GANGWAYS

Aluminum Gangways

Stability: Cool, slip-resistant surface provides maximum stability and support as you walk to your dock or launch.

Durability: Capacity of 50 lbs. per square foot, with welded aluminum walkway structure

Customization: Can be customized with components designed to make it easier to link the shore, gangway and dock together.

EZ Dock's aluminum gangways are well suited for residential or commercial applications in both fresh and saltwater. The gangways are made from corrosion resistant 6000 series aluminum and are not only strong, but they are low maintenance and can be easily cleaned. No painting or staining is required to keep them looking great for years to come. Constructed in accordance with the minimum provisions of States Organizations for Boating Access (SOBA), standard EZ Dock aluminum gangways also meet ADA guidelines. The gangways offer continuous handrails extending 12 inches past the walking surface on both ends, and kick plates are standard features. Aluminum gangways support 90 pounds per linear foot and a concentrated load of 400 pounds applied to any 12" X 12" area. This latest version of the aluminum gangways is more rigid and yet adapts to all types of weather conditions. They include detachable handrails, making the shipping, handling, and assembly significantly less labor intensive. The slip resistant decking used is specifically made for marine applications. It has a mill-finish and knurl pattern to provide for better footing. The gangways come in 3' and 5' widths, with length options from 8' to 32'. The gangways are compatible with all existing EZ Dock shore mounts, rollers and transition plates.

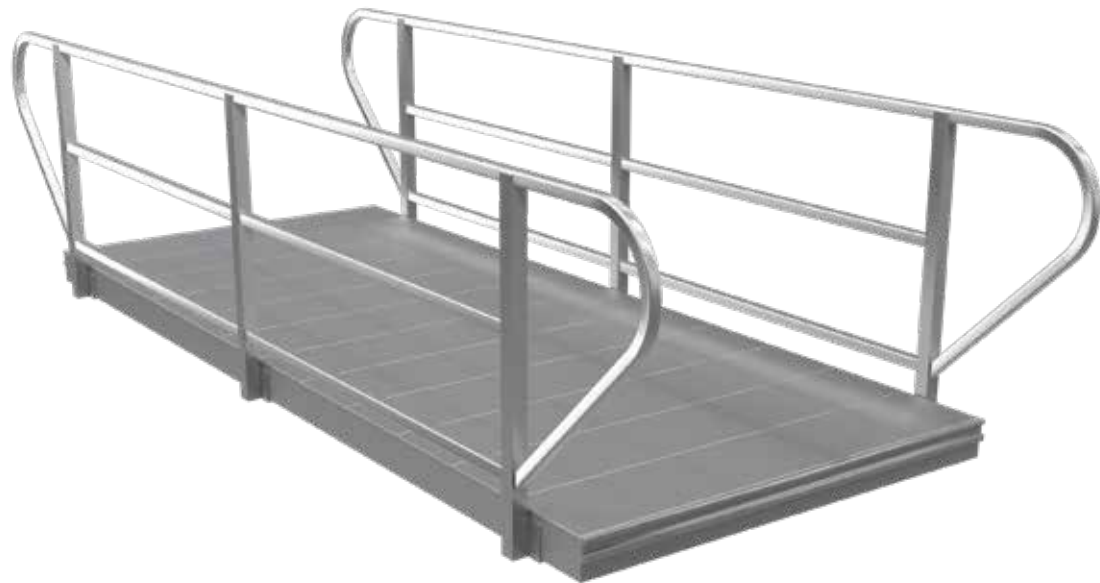

Aluminum Gangways - 3' Wide, Aluminum Decking, Detachable Aluminum Railing and Hardware

PART #	MODEL - PRODUCT DESCRIPTION	LENGTH	WIDTH (Inside)	WIDTH (Outside)	WEIGHT
G400308	Gangway AL 3' x 8' w/hardware, railings, AL deck	8'	36"	41"	202
G400312	Gangway AL 3' x 12' w/hardware, railings, AL deck	12'	36"	41"	281
G400316	Gangway AL 3' x 16' w/hardware, railings, AL deck	16'	36"	41"	372
G400320	Gangway AL 3' x 20' w/hardware, railings, AL deck	20'	36"	41"	449
G400324	Gangway AL 3' x 24' w/hardware, railings, AL deck	24'	36"	41"	524
G400328	Gangway AL 3' x 28' w/hardware, railings, AL deck	28'	36"	41"	618
G400332	Gangway AL 3' x 32' w/hardware, railings, AL deck	32'	36"	41"	688

Aluminum Gangways - 5' Wide, Aluminum Decking, Detachable Aluminum Railing and Hardware

PART #	MODEL - PRODUCT DESCRIPTION	LENGTH	WIDTH (Inside)	WIDTH (Outside)	WEIGHT
G400508	Gangway AL 5' x 8' w/hardware, railings, AL deck	8'	60"	65"	262
G400512	Gangway AL 5' x 12' w/hardware, railings, AL deck	12'	60"	65"	365
G400516	Gangway AL 5' x 16' w/hardware, railings, AL deck	16'	60"	65"	480
G400520	Gangway AL 5' x 20' w/hardware, railings, AL deck	20'	60"	65"	585
G400524	Gangway AL 5' x 24' w/hardware, railings, AL deck	24'	60"	65"	687
G400528	Gangway AL 5' x 28' w/hardware, railings, AL deck	28'	60"	65"	805
G400532	Gangway AL 5' x 32' w/hardware, railings, AL deck	32'	60"	65"	900

GANGWAYS

Polyethylene Gangways

Engineered with the same technology and quality as our dock sections, EZ Dock gangways offer uncompromised durability and modular versatility. Gangways are manufactured from aluminum or polyethylene.

Molded Plastic Gangway
US Pat. 6912966

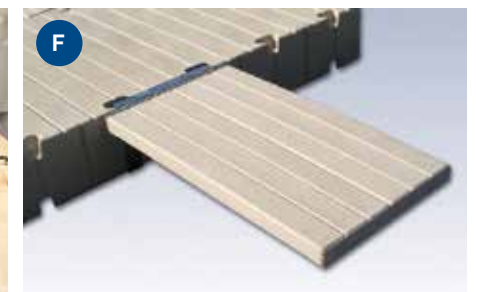
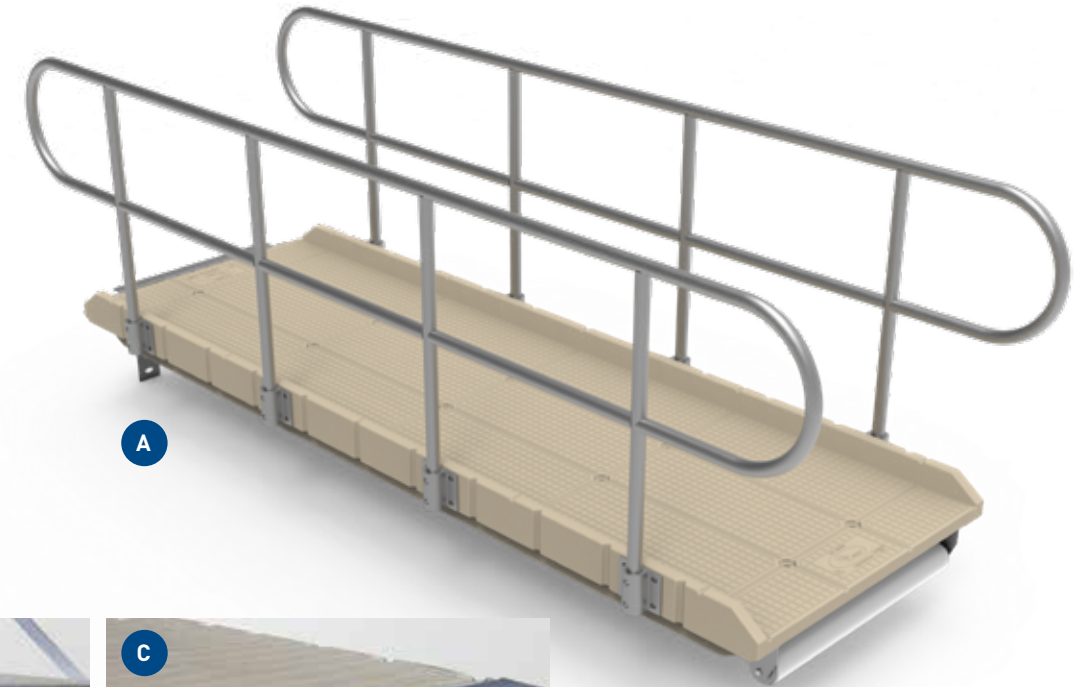

A-Polyethylene Gangway

404010

10' section polyethylene gangway. (Railing sold separately.)

B-Gangway Roller Kit

300300, 300400

Gangway Roller Kit allows end of gangway to adjust to changing water levels. PVC and galvanized steel roller available for 3' and 5' widths.

C-Hinge-To-Float

G200360, G200560

Hinged bracket with hardware attaches gangway to dock.

D-Transition Kit (Polyethylene)

100717 (15") or 100718 (30")

Hinged polyethylene plate creates a smooth transition between EZ Dock or EZ Port and another floating dock.

E-Gangplank Mounting Kit

100240, 100340 or 100600

Galvanized steel hinge bracket and hardware for wood walkways 24", 34", or 60" wide. Lumber not included.

F-Plank Gangway (Polyethylene)

200200

Hinged polyethylene panel creates a smooth transition between shore grade and deck surface.

PRODUCT SPECIFICATION GUIDE 2021



THE BEST WORLDWIDE DISTRIBUTION NETWORK IN THE INDUSTRY FOR MORE INFORMATION, VISIT ez-dock.com | 800-654-8168

The EZ Dock global network of highly trained and knowledgeable dealers and distributors is ready to help. Our experienced team is standing by to help you choose a system that will maximize your space and suit your specific application.

Call or visit our website at ez-dock.com to create your perfect dock,
or to find your local EZ Dock dealer.

US/Canada	1-800-654-8168
Europe	+46 (0) 380 47 300
International	+1-417-235-2223



EZ Dock product is produced in our Monett, MO facility which is certified by Intertek for ISO 9001:2015 quality management system and ISO 14001: 2015 environmental management system. EZ Dock is a supplier to the U.S. General Services Administration. You can shop for EZ Dock product electronically from the GSA Advantage website. The EZ Dock GSA number is: GS-07F-0271V

EZ Dock may introduce new colors, products, accessories and options throughout the year. Specifications and products listed are subject to change without notice. Some products may be shown with additional or optional equipment not available through EZ Dock. Specifications may vary for international shipments. Please check with your local dealer for more information. EZ Dock is a product of the U.S.A.

EZ Dock, Inc | 878 HWY 60, Monett, MO 65708 | 417-235-2223 | 800-654-8168

© 2021 EZ Dock, Inc. All rights reserved.